

# TORA CLASSIC - TOR4072

INS-V2

ALL MEASUREMENTS ARE IN MILLIMETRES

MANUFACTURED FROM STAINLESS STEEL

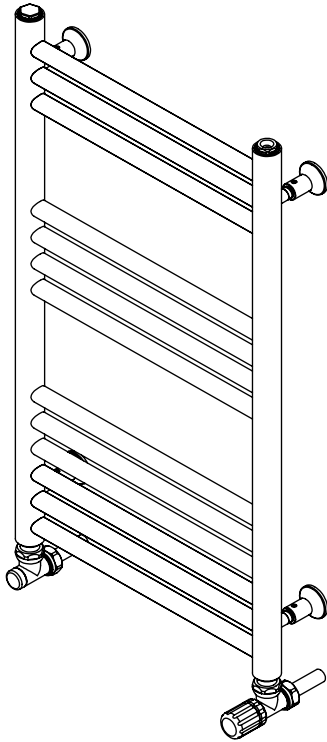

## Installation Accessories

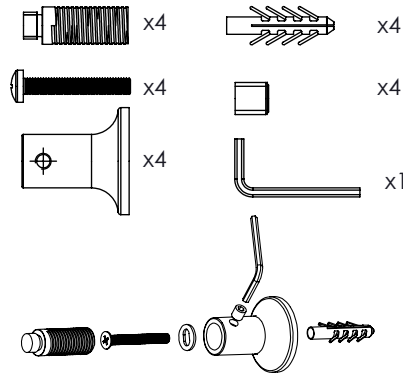

## Fitting Position

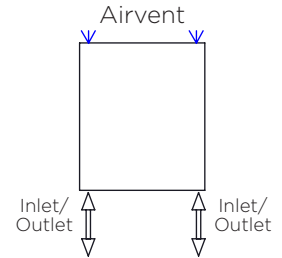

Vertical Mount  
 All Dimensions are in mm  
 Max.Working Pressure = 10 Bar  
 Max.Working Temperature = 95°  
 Inlet/Outlet: 1/2" BSP  
 Fuel: E/H/D

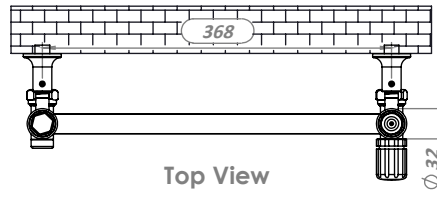

Top View

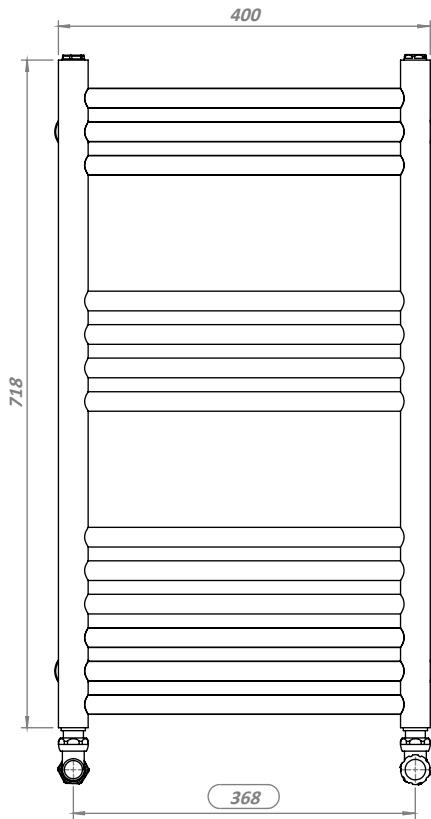

Front View

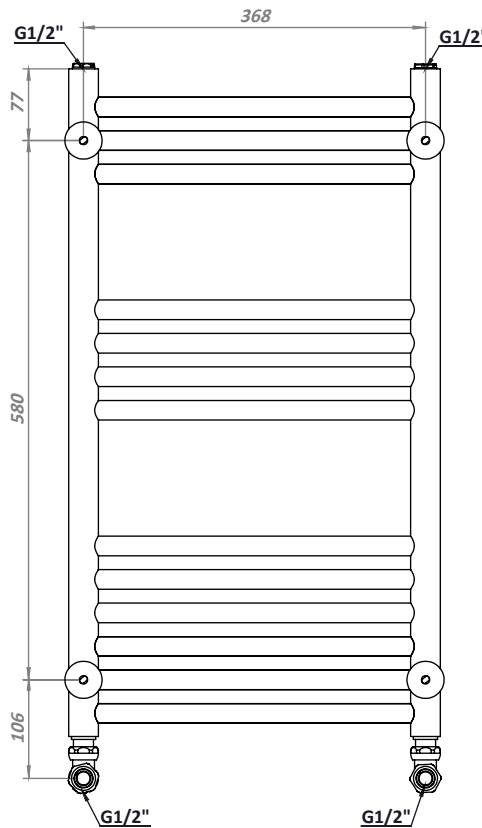

Back View

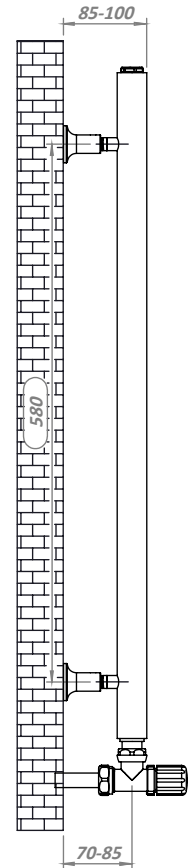

Side View

Technical specifications are subject to change without prior notice.

AEON is the designer heating division of Pitacs Limited.  
 Pitacs Limited, Bradbourne Point, Bradbourne Drive, Tilbrook, Milton Keynes,  
 Buckinghamshire, MK7 8AT, UK

T: +44 (0)1908 271155 E: info@pitacs.com W: www.aeon.uk.com

