

# WAVE HORIZONTAL

INS-VS1

ALL MEASUREMENTS ARE IN MILLIMETRES

MANUFACTURED FROM STAINLESS STEEL

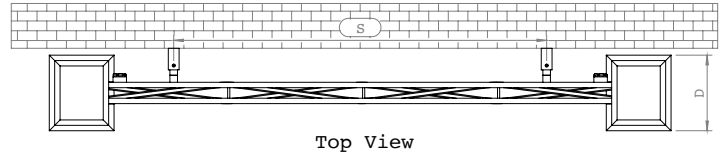
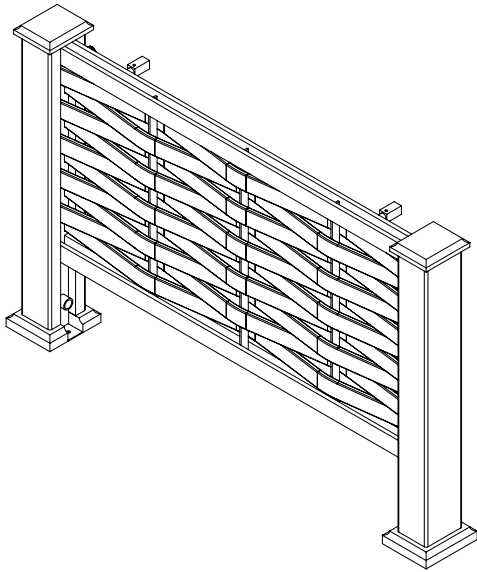

Top View

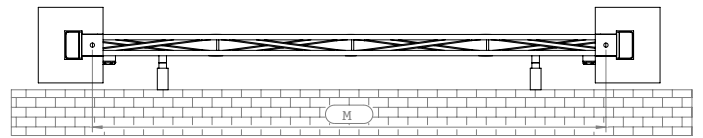

Bottom View

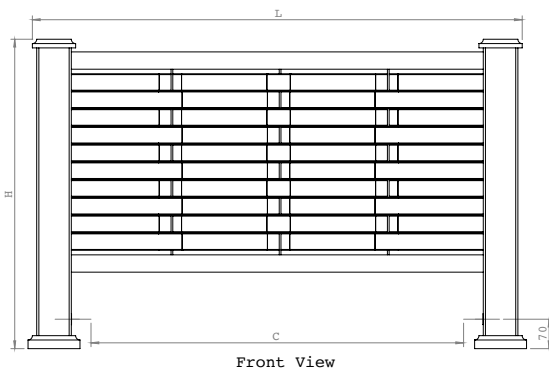

Front View

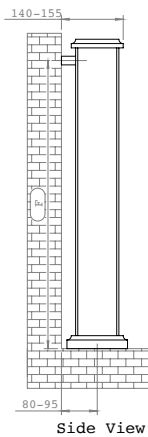

Side View

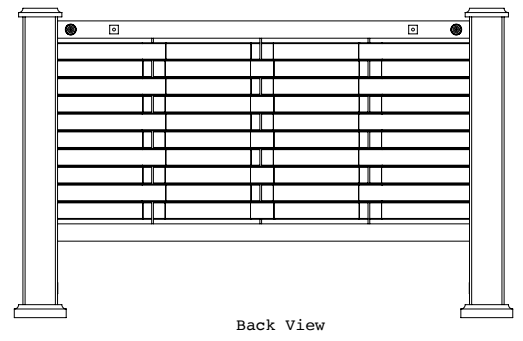

Back View

## Plumbing Position

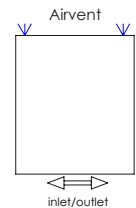

## Installation Accessories:

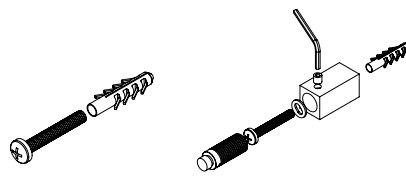
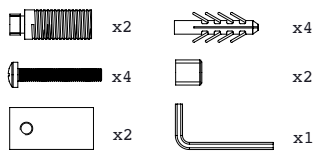

PRODUCT CODE	Height	Length	Depth	Pipe Centres	Bracket Centres		
	H	L	D	C	F	S	M
	mm	mm	mm	mm	mm	mm	mm
WA710h	715	1150	100	860	665	690	950
WA715h	715	1650	100	1360	665	1190	1450
WA720h	715	2150	100	1860	665	1690	1950
Stainless Steel (WSSS)*	S.Steel	Pillars	Pair	-	-	-	-
Nero Assuloto (WSNA)*	Granite	Pillars	Pair	-	-	-	-
Travertine Classico (WSTC)*	Travertine	Pillars	Pair	-	-	-	-
Crema Marfil (WSCM)*	Marble	Pillars	Pair	-	-	-	-
Verde Butterfly (WSVB)*	Granite	Pillars	Pair	-	-	-	-
Labrador Antique (WSLA)*	Granite	Pillars	Pair	-	-	-	-

Vertical mount  
All Dimensions are in m  
Max.Working Pressure: 5  
Max.Working Temperature  
Inlet / Outlet : 1/2" B  
Fuel : H

Manufacturing Tolerance : - 5 mm

Technical specifications are subject to change without prior notice.



AEON is the designer heating division of Pitacs Limited.  
Pitacs Limited, Bradbourne Point, Bradbourne Drive, Tilbrook, Milton Keynes,  
Buckinghamshire, MK7 8AT, UK

T: +44 (0)1908 271155 E: info@pitacs.com W: www.aeon.uk.com