

TORA MITRED - TOR410-7M

INS-VS1

ALL MEASUREMENTS ARE IN MILLIMETRES

MANUFACTURED FROM STAINLESS STEEL

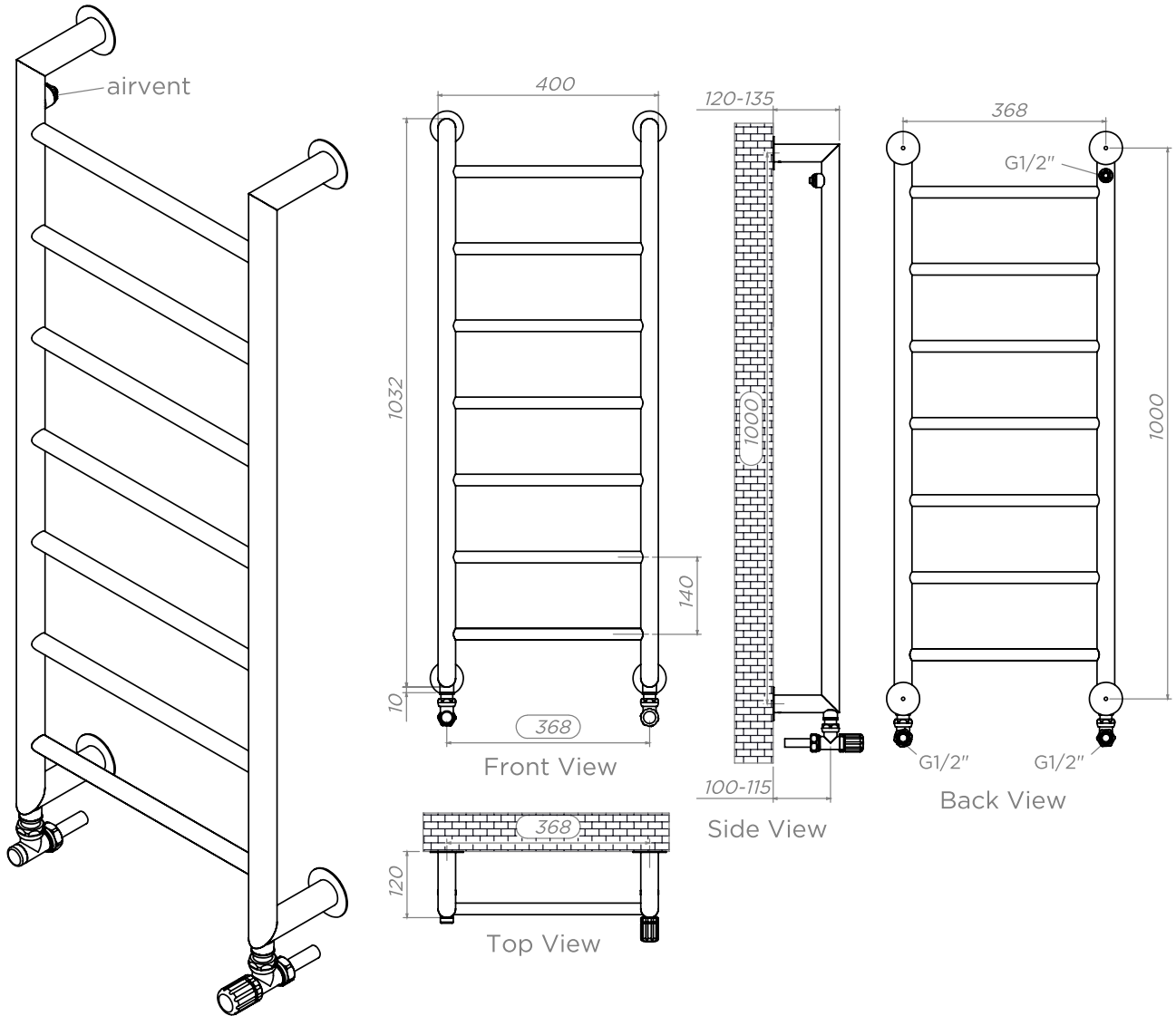

Installation Accessories

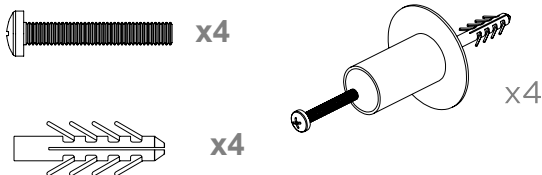

Fitting Position

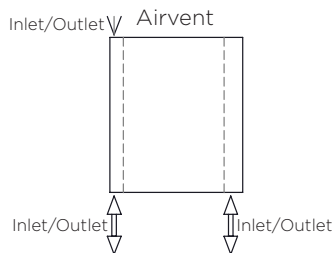

Vertical Mount
 All Dimensions are in mm
 Max.Working Pressure = 10 Bar
 Max.Working Temperature = 120°C
 Inlet/Outlet: 1/2" BSP

Technical specifications are subject to change without prior notice.



AEON is the designer heating division of Pitacs Limited.
 Pitacs Limited, Bradbourne Point, Bradbourne Drive, Tilbrook, Milton Keynes,
 Buckinghamshire, MK7 8AT, UK

T: +44 (0)1908 271155 E: info@pitacs.com W: www.aeon.uk.com