

SERIF

INS-VS1

ALL MEASUREMENTS ARE IN MILLIMETRES

MANUFACTURED FROM STAINLESS STEEL

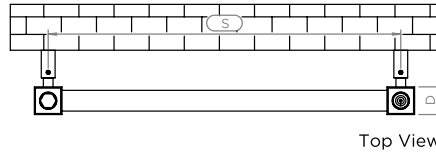
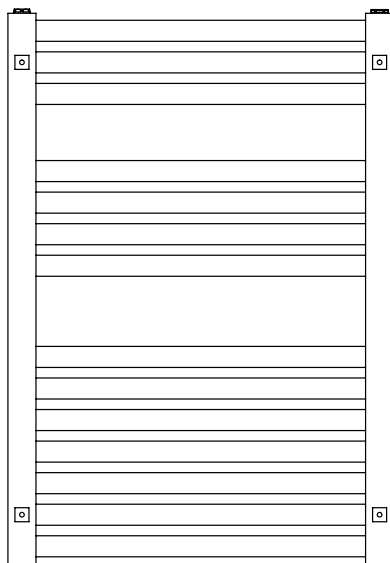
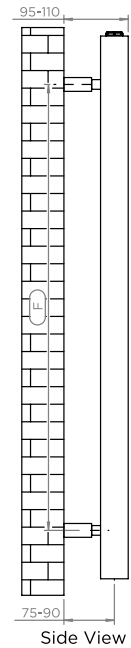
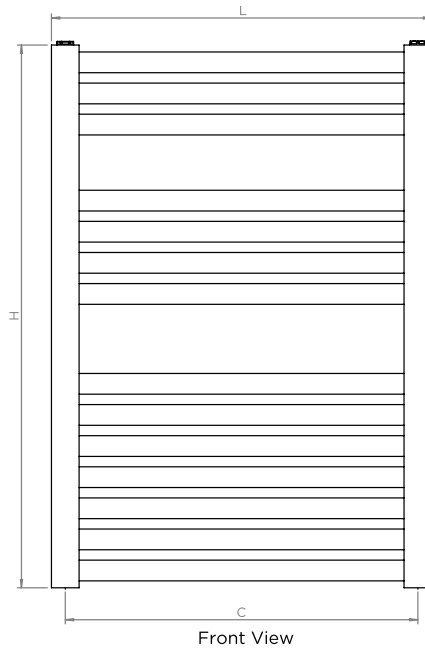
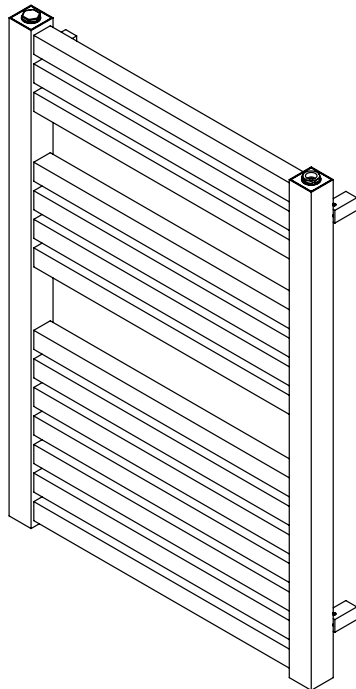

Installation Accessories:

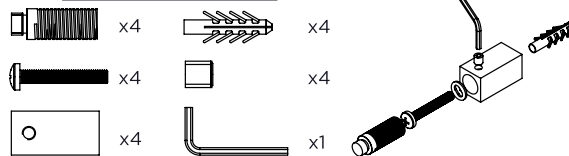

Back View

Plumbing Position:

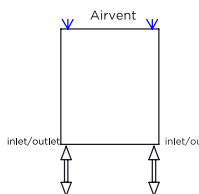

Vertical mount
 All Dimensions are in mm
 Max. Working Pressure: 10 Bar
 Max. Working Temperature: 95° C
 Inlet / Outlet : 1/2" BSP
 Fuel : E/H/D

Manufacturing Tolerance : - 5 mm

PRODUCT CODE	Height		Length		Depth	Pipe Centres		Bracket Centres	
	H	L	L	D	D	C	F	S	
	mm	mm	mm	mm	mm	mm	mm	mm	
SRF558	785	550	40	510	40	510	645	510	
SRF5512	1200	550	40	510	40	510	1060	510	
SRF5517	1660	550	40	510	40	510	1520	510	

FR.7I-Rev.00

Technical specifications are subject to change without prior notice.

AEON is the designer heating division of Pitacs Limited.
 Pitacs Limited, Bradbourne Point, Bradbourne Drive, Tilbrook, Milton Keynes,
 Buckinghamshire, MK7 8AT, UK

T: +44 (0)1908 271155 E: info@pitacs.com W: www.aeon.uk.com

