

# MADONNA - MAD400

INS-VS1

ALL MEASUREMENTS ARE IN MILLIMETRES

MANUFACTURED FROM STAINLESS STEEL

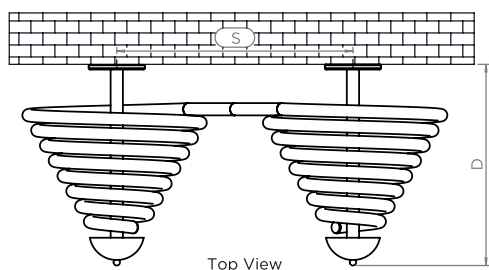
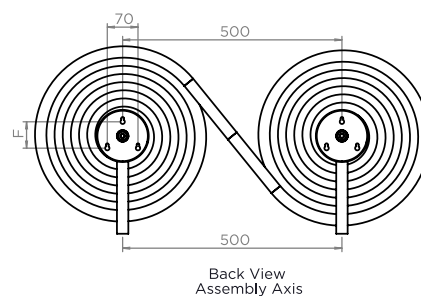
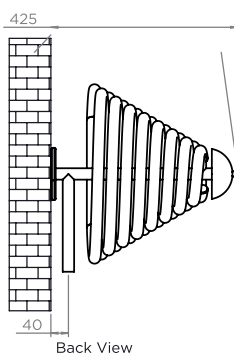
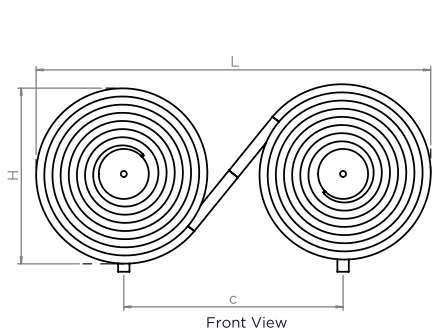
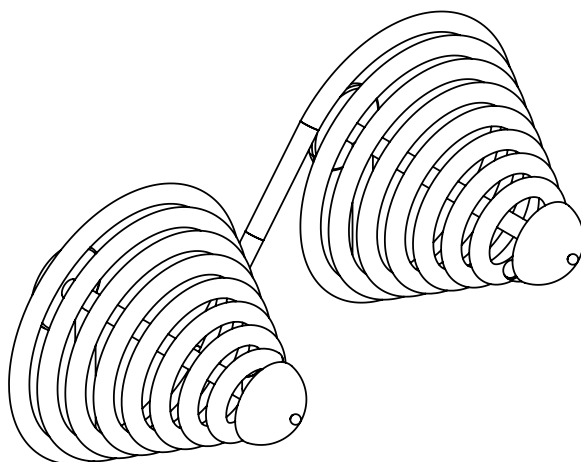

### Installation Accessories:

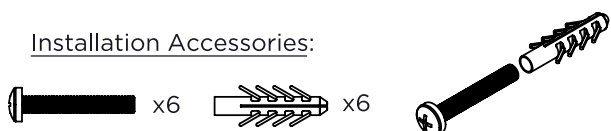

### Plumbing Position:

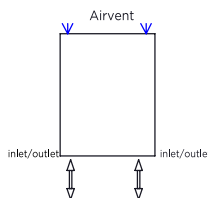

Horizontal mount  
All Dimensions are in mm  
Max. Working Pressure: 10 Bar  
Max. Working Temperature: 95° C  
Inlet / Outlet : 1/2" BSP  
Fuel : H  
Manufacturing Tolerance : - 5 mm

PRODUCT CODE	Height	Length	Depth	Pipe Centres	Bracket Centres	
	H mm	L mm	D mm	C mm	F mm	S mm
MAD400	400	900	425	500	60	500

Technical specifications are subject to change without prior notice.

AEON is the designer heating division of Pitacs Limited.  
Pitacs Limited, Bradbourne Point, Bradbourne Drive, Tilbrook, Milton Keynes,  
Buckinghamshire, MK7 8AT, UK

T: +44 (0)1908 271155 E: info@pitacs.com W: www.aeon.uk.com

