

COFFER VERTICAL

ALL MEASUREMENTS ARE IN MILLIMETRES

MANUFACTURED FROM STAINLESS STEEL

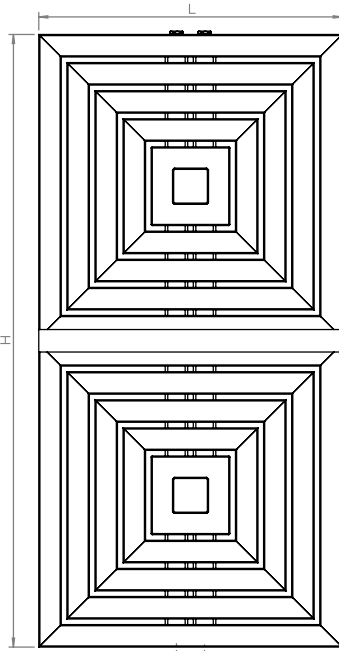
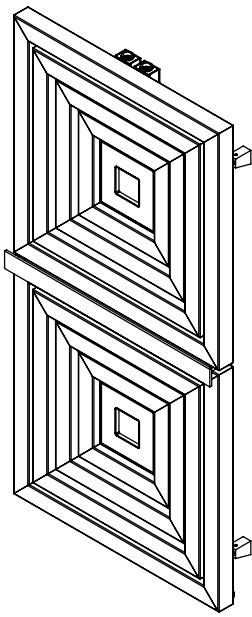

Front View

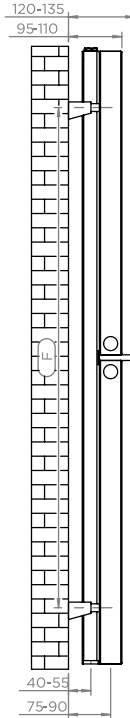

Side View

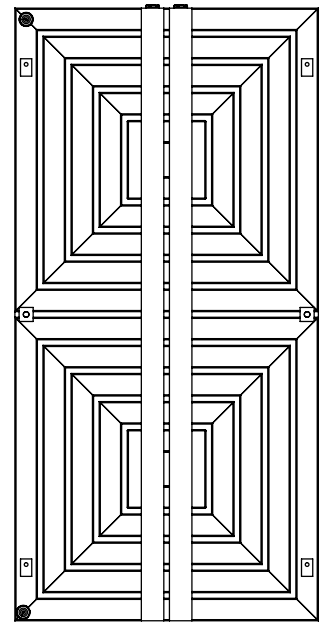

Back View

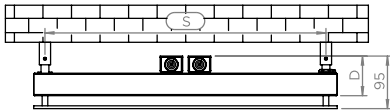

Top View

Installation Accessories:

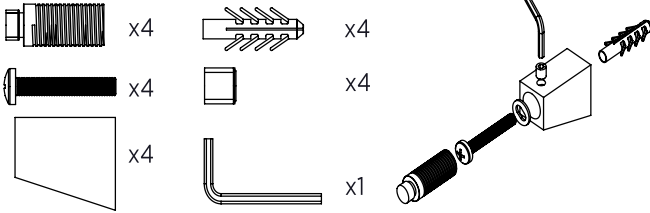

Plumbing Position:

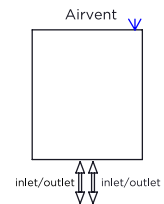

Vertical mount
 All Dimensions are in mm
 Max. Working Pressure: 10 Bar
 Max. Working Temperature: 95° C
 Inlet / Outlet : 1/2" BSP
 Fuel : E/H/D

Manufacturing Tolerance : - 5 mm

PRODUCT CODE	Height	Length	Depth	Pipe Centres	Bracket Centres	
	H mm	L mm	D mm	C mm	F mm	S mm
COF490	890	440	70	50	690	400
COF511	1090	540	70	50	890	500

Technical specifications are subject to change without prior notice.



AEON is the designer heating division of Pitacs Limited.
 Pitacs Limited, Bradbourne Point, Bradbourne Drive, Tilbrook, Milton Keynes,
 Buckinghamshire, MK7 8AT, UK

T: +44 (0)1908 271155 E: info@pitacs.com W: www.aeon.uk.com

COFFER HORIZONTAL

ALL MEASUREMENTS ARE IN MILLIMETRES

MANUFACTURED FROM STAINLESS STEEL

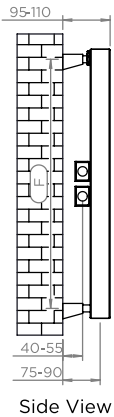
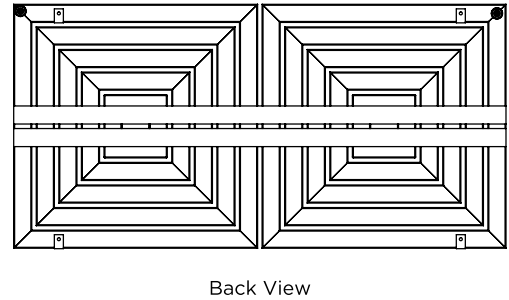
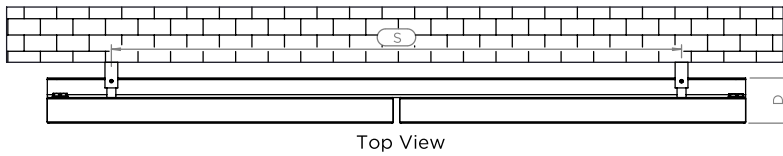
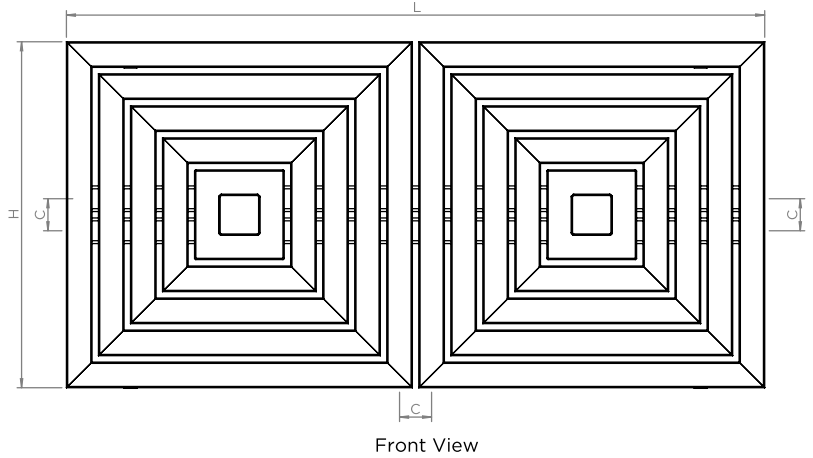
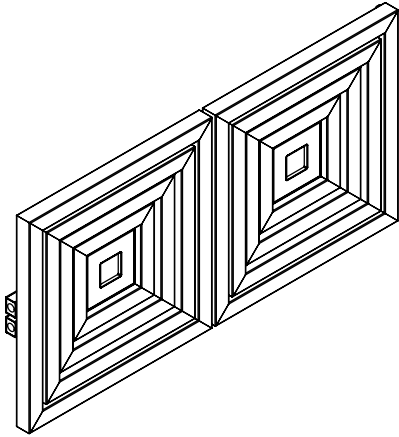

Installation Accessories:

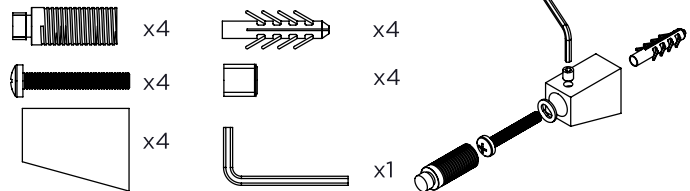

Plumbing Position:

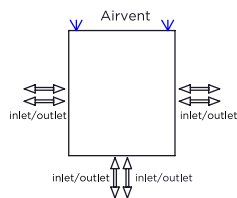

Horizontal mount
 All Dimensions are in mm
 Max. Working Pressure: 10 Bar
 Max. Working Temperature: 95° C
 Inlet / Outlet : 1/2" BSP
 Fuel : E/H/D

Manufacturing Tolerance : - 5 mm

PRODUCT CODE	Height	Length	Depth	Pipe Centres	Bracket Centres	
	H	L	D	C	F	S
	mm	mm	mm	mm	mm	mm
COF490	890	440	70	50	400	690
COF511	1090	540	70	50	500	890

Technical specifications are subject to change without prior notice.

AEON is the designer heating division of Pitacs Limited.
 Pitacs Limited, Bradbourne Point, Bradbourne Drive, Tilbrook, Milton Keynes,
 Buckinghamshire, MK7 8AT, UK

T: +44 (0)1908 271155 E: info@pitacs.com W: www.aeon.uk.com

